

WILO Hocheffizienzpumpen höherer Leistung für Sole-EWT-Anwendungen in Kombination mit Netec Solepumpenregler HTR2-2



Zur Kombination mit Netec-Solepumpenregler HTR2-2 kommen alle Stratos-Pumpen in Frage, die im WILO-OEM-Katalog für Hocheffizienzpumpen (Version 13.02, September 2013) in der Rubrik "Geothermie-Pumpen" auf Seiten 133-152 dargestellt sind, sofern sie eine PWM-2 Ansteuerung haben.

Je nach Pumpenmodell müssen das Leistungsstrom- und das Steuerstromkabel an der Pumpe bauseits angeklemt werden. Am Netec Regler sind Kabel mit System-Endsteckern montiert.

Diese Pumpen der WILO Stratos-Baureihe sind über Netec erhältlich.

Für Preisanfragen bitte genaues Pumpenmodell benennen

Catalogue Building Services September 2013

OEM High Efficiency Circulation Pumps

Glandless Pumps and Accessories



General notes

Abbreviations and Introduction

Abbreviation	Meaning
1~	1-phase current
Δp	Differential pressure
$\Delta p-c$	Control mode for constant differential pressure
$\Delta p-v$	Control mode for variable differential pressure
EM	Single-phase motor, 1~
EnEV	German Energy Conservation Legislation
ErP	It applies to energy-related products. ErP Directive 2009/125/EC establishing a framework for the setting of environmentally-responsible requirements for energy-driven products. Formerly the Ecodesign Directive (EuP Directive 2005/32/EC).
ECM technology	Electronically commutated motor with new wet rotor encapsulation, newly developed glandless drive concept for high-efficiency pumps
°dH	Degree of German water hardness; replaced by the SI unit mmol/l; conversion 1 °dH = 0.1783 mmol/l
H, Hman	Delivery head
Cataphoretic coating	Cataphoretic coating (electrophoretically deposited paint, EDP): paintwork with high adhesive strength for long-lasting corrosion protection
P_1	Power consumption (power supplied from the network)
PN	Pressure class in bar (e.g. PN10 = suitable up to 10 bar)
PWM	Pulse-width modulation. PWM signal for external activation of functions
$Q (= \dot{V})$	Volume flow
SBM	Run signal or collective run signal
SSM	Fault signal or collective fault signal
Control input, 0 - 10 V	Analogue input for external control
TrinkwV 2001	German Drinking Water Ordinance of 2001 (valid from 01.01.2003)
VDI 2035	VDI guideline for preventing damage in hot-water heating installations

Introduction

As the first high-efficiency pump in the world, the Wilo-Stratos defined energy efficiency class A for stand-alone circulators, thereby setting a new standard. Wilo extended this product technology towards new pump ranges especially for requirements of the OEM industry. The product ranges Wilo-Yonos PARA, Wilo-Stratos PARA are the new generations of high-efficiency pumps especially designed in line with the demands of OEM industry regarding hydraulic performance, scope of functionality, space restrictions and costs. The scope of all pump ranges is precisely tailored to meet the individual requirements of the market and customers and have the following advantages:

- Concentrating on the essentials
- Maximum efficiency thanks to ECM technology
- Up to 80% energy savings compared with uncontrolled circulators
- Meet all the new requirements of the ErP directive (2009/125/EC)
- For heating, solar, geothermal energy systems and cooling
- Intelligent design
- Optimal performance in the smallest space
- High starting torque for reliable starting
- Prevention of flow noise
- Quick and safe installation thanks to a standard delivery with cable or plug for an easy electrical connection
- Simple operation and convenient setting of the pump via external control signals or the Red Button technology
- Cast iron pump housing with cataphoretic (KTL) coating for the prevention of corrosion from condensation formation
- Large range of composite housings for heating applications

General notes

High-efficiency pumps

High-efficiency pumps

The efficiency of the hydraulics and the motor determine the pump's overall efficiency. Both components were doubled with the Wilo-Stratos pump compared to the glandless pumps previously used in building services, thus resulting in a considerable improvement. The applied ECM technology drastically reduces the annual power consumption, which again results in considerable savings compared to conventional pumps.

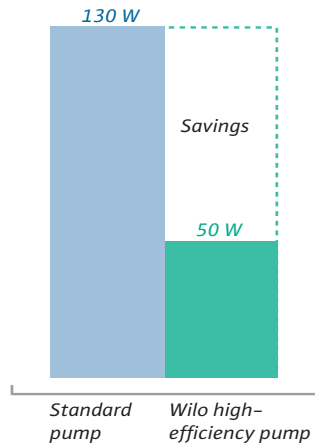

ECM technology

The new ECM technology is the basis for the outstanding efficiency of the Wilo-OEM series Yonos PARA and Stratos PARA. It includes:

EC motor

EC motor stands for electronically commutated motor. Its basis is a synchronous motor with permanent magnet rotor. The rotating stator's magnetic field is generated by electronic commutation, meaning that the stator windings are activated specifically for the interaction of the electrical and magnetic poles.

This has the following benefits:

- The magnetic field required in the rotor does not need to be generated with any losses.
- Especially in the partial load range (up to 98% of the operating time), the difference in efficiency is even greater than it already is in the full load range compared to an asynchronous motor.
- Higher speeds are possible compared to an asynchronous motor. This results in the reduction of the size and weight of the pump with similar hydraulics.

Wet rotor encapsulation

The rotor of the glandless pump motor runs in the fluid. This fluid lubricates the bearings and cools the motor. The current-carrying stator is separated from the fluid by a can, referred to as wet rotor encapsulation. This wet rotor encapsulation has a direct effect on the efficiency

- due to the size of the necessary gap between stator and rotor,
 - and due to the magnetic resistance of the selected can material.
- The improvement in terms of efficiency of the Wilo-Stratos/Yonos pump here is the result of:
- Reduction of the air gap and
 - Application of an innovative can material with smaller losses to the magnetic flux between stator and rotor.

Motor protection

The standard integrated protection device reliably protects the Wilo-Yonos PARA and Wilo-Stratos PARA, in all settings, against excess temperature, low/excess voltage, excess current, blocking as well as dry running.

This has the following advantage:

No external motor protection switch is required. The connecting instructions of the local electricity supply companies are to be observed.

Minimum inlet pressure for the prevention of cavitation

To prevent cavitation (vapour bubble formation within the pump), it is necessary to maintain a sufficiently high over pressure (suction head) at the pump suction port in relation to the vapour pressure of the fluid being pumped.

The minimum suction heads are listed in the respective tables for all glandless pumps.

For higher altitudes than 300 m above sea level:

add 0,1 m head/100 m height increase.

These minimum heads must be respectively increased when handling fluids of higher temperatures or lower densities, higher resistances at the circulator suction side and in regions of lower atmospheric pressures.

Pump curves

All pump curves included in the catalogue apply to the pumping of water (kinematic viscosity = 1 mm²/s). If fluids of different density and/or viscosity are pumped (e.g. water-glycol mixtures), the hydraulic values of the pump and the pipe system will deviate. It is recommended that the data is only measured after a minimum of 24h running-in.

Minimum volume flow

Larger pumps require a minimum flow rate to ensure trouble-free operation. Operating against a closed slide valve, volume flow $Q = 0 \text{ m}^3/\text{h}$, can lead to overheating inside the pump.

Standards/directives

- CE marking (all Wilo pumps)
- Certification according to:
 - ISO 9001,
 - ISO 14001

Quality and safety mark



For pump types:

Wilo-Yonos PARA
Wilo-Stratos PARA

Wilo-Stratos PARA



The Wilo-Stratos PARA is a Wilo high-efficiency pump series in glandless construction which can be used both for

- Hot-water heating systems of all kinds
- Closed cooling circuits
- Industrial circulation systems
- Circulation in solar thermal and geothermal systems
- Secondary hot water circulation systems of all kinds (Stratos PARA-Z) in all OEM applications and it offers the following advantages:

Special features/product benefits

- Maximum efficiency thanks to ECM technology
- Up to 80% electricity savings compared to old uncontrolled heating pumps
- High starting torque for reliable start-up
- Can be used in hot water heating systems of all kinds, geothermal and solar thermal systems, closed cooling circuits, industrial circulation systems in the temperature range of -10 °C to $+95\text{ °C}$ ($+110\text{ °C}$)
- Prevention of flow noise
- Reliability and comfort during installation and operation
- Functions adapted specially to the demands of the OEM market and space-saving design.
- Optimum performance also in tight installation situations.
- Delivery as standard with a cable for an easy electrical connection
- Convenient setting of the pump via external control signals or the Red-Button technology
- Cathodoretically coated (KTL) cast iron pump housing to prevent corrosion when condensation occurs

Heating application

The Wilo-Stratos PARA pumps are specially designed for the use in higher ambient temperatures which may occur in OEM systems in heating applications due their space-reduced construction.

Thermal insulation for heating

To avoid heat losses via the pump housing, the single pump series Wilo-Stratos PARA / Stratos PARA-Z come optionally with a thermal insulation shell. The PP material used, foamed polypropylene, has the following properties:

- Environmental compatibility: easily recyclable
- Thermal resistance: up to 120 °C
- Transmission coefficient: 0.04 W/mK according to DIN 52612
- Flammability: Class B2 according to DIN 4102 (normally flammable) Normally flammable materials are permitted for use in heated rooms in Germany in accordance with fire prevention regulations as long as a minimum clearance of 20 cm is maintained between them and the fireplace.

Cooling application

Condensation takes place on cold surfaces if the fluid temperature is lower than the ambient air temperature. The Wilo-Stratos PARA can also be used in such conditions. They are constructed in a way that damage to electrical parts caused by condensation water is prevented.

Thermal insulation for cooling

If the Wilo-Stratos PARA pumps are used at low temperatures in geothermal or cooling applications, the insulation must not cover the drain labyrinth between the pump housing/motor. Only then can any condensate having possibly accumulated in the motor drain off freely through the condensate drain openings in the motor housing.

The diffusion-proof Wilo-Cooling-Shell insulation available as accessory for the Wilo-Stratos PARA series for the purpose of insulating pump housings in cold water applications ensures this automatically due to its specific design.

Wilo-Cooling-Shell:

- Water vapour diffusion resistance > 7000
- Normally flammable, according to DIN 4102-B2
- Part 1 quality-monitored as per DIN 18200

Corrosion-proof pump design

Corrosion-proof designs are required for e.g. radiant cooling or heating ceiling panels. For these applications, the pump housing is coated. As an alternative, the Wilo-Stratos PARA-Z with its corrosion-resistant pump housing made of red brass can be utilised as the highest-quality version available.

Sanitary hot water application

(Wilo-Stratos PARA-Z)

Pumps which are utilised in sanitary hot water circulation systems are subject to specific requirements that are fulfilled by the Wilo-Stratos PARA-Z series:

- Fluids are potable water and water for food companies according to TrinkwV 2001. Possible deposits of lime were considered in the design so that a total carbonate hardness of 20 °d at a max. fluid temperature of $+80\text{ °C}$ is permitted.
- All plastic parts that come into contact with the pumped liquid comply with KTW recommendations.

Sound pressure level

Glandless pumps are low-noise due to their design. Their air-borne noise values with measuring-surface sound pressure level L_p (A) [dB] depend on the motor power output, and are determined under normal operating conditions.

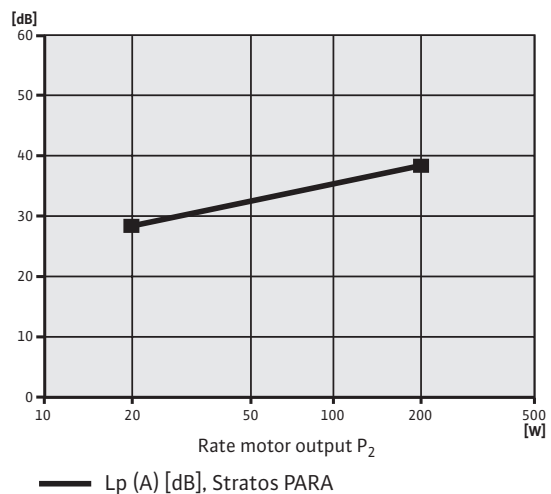

Planning guide

Wilco-Stratos PARA

Electronic performance control

Available control modes

Control mode Δp -c:

In the Δp -c control mode, the electronic module keeps the differential pressure generated by the pump constant at the set differential pressure setpoint H_s over the permissible volume flow range.

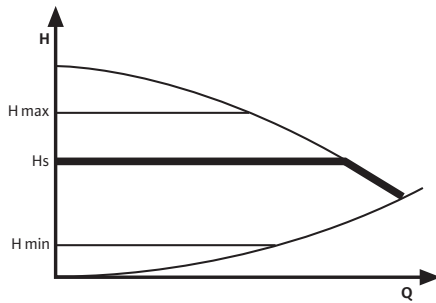

Control mode Δp -v:

In the Δp -v control mode, the electronic module changes the differential pressure setpoint to be maintained by the pump in linear fashion between H_s and $\frac{1}{2} H_s$. The differential pressure setpoint value H varies with the volume flow Q .

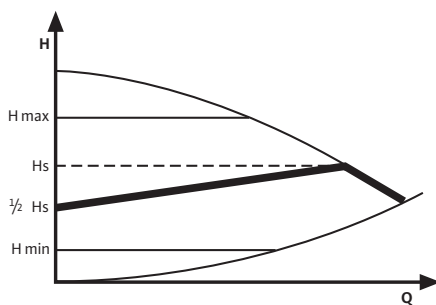

External control functions: ext. in

Control input "0-10 V" (Analogue In)

The actual/setpoint level assessment required for control is referred to a remote controller. The remote controller sends an analogue signal (0 - 10 V) as an actuating variable to the Wilco-Stratos PARA.

- Electric strength 24V DC
- Input resistance of voltage input >100kOhm

Analogue In 0-10V with cable break detection

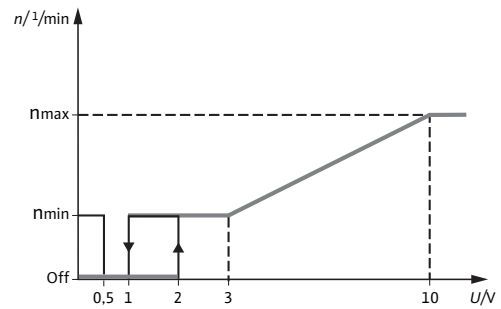

- $0.5 \text{ V} < U < 1 \text{ V}$: Pump stops
- $1 \text{ V} < U < 3 \text{ V}$: Pump runs at minimum speed (operation)
- $2 \text{ V} < U < 3 \text{ V}$: Pump runs at minimum speed (start-up)
- $3 \text{ V} < U < 10 \text{ V}$: Speed varies between n_{min} and n_{max} (linear)
- $U < 0.5 \text{ V}$: Cable break detection, the pump runs at minimum speed (emergency operation)

Analogue In 0-10V without cable break detection

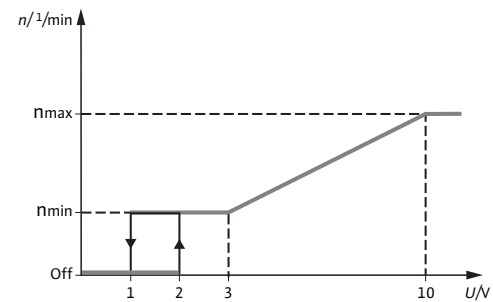

- $U < 1 \text{ V}$: Pump stops
- $1 \text{ V} < U < 3 \text{ V}$: Pump runs at minimum speed (operation)
- $2 \text{ V} < U < 3 \text{ V}$: Pump runs at minimum speed (start-up)
- $3 \text{ V} < U < 10 \text{ V}$: Speed varies between n_{min} and n_{max} (linear)

Wilo-Stratos PARA

External control via a PWM signal

The actual/setpoint level assessment required for control is referred to a remote controller. The remote controller sends a PWM signal as an actuating variable to the Wilo-Stratos PARA.

The PWM signal generator gives a periodic order of pulses to the pump (the duty cycle), according to DIN IEC 60469-1. The actuating variable is determined by the ratio between pulse duration and the pulse period. The duty cycle is defined as a ratio without dimension, with a value of 0 ... 1 % or 0 ... 100 %. This is explained in the following with ideal pulses which form a rectangular wave.

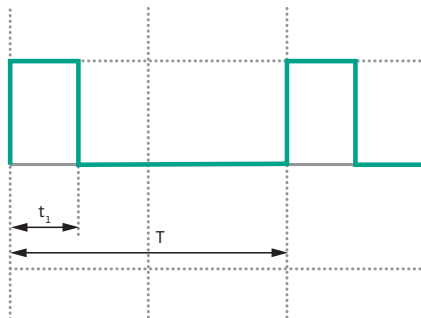

$$t_1 / T = 0,25 = 25\%$$

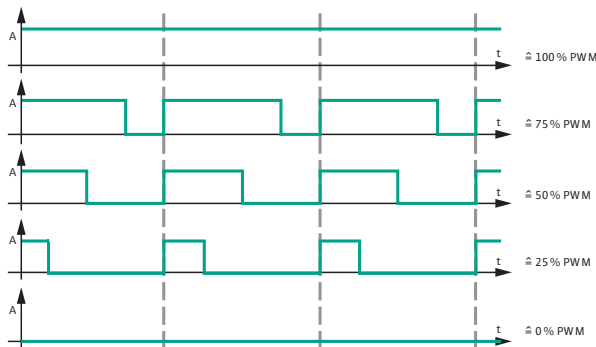

PWM signal logic 1 (heating):

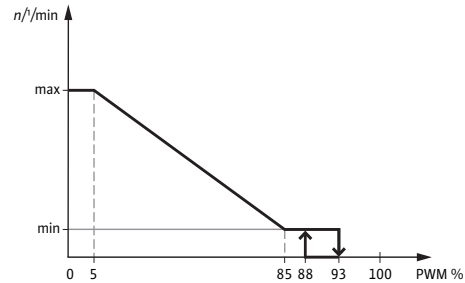

PWM input signal [%]

- < 5 Pump runs at maximum speed
- 5-85 Pump speed decreases linearly from maximum to minimum
- 85-93 Pump runs at minimum speed (operation)
- 85-88 Pump runs at minimum speed (start-up)
- 93-100 Pump stops (Standby)

PWM signal logic 2 (solar):

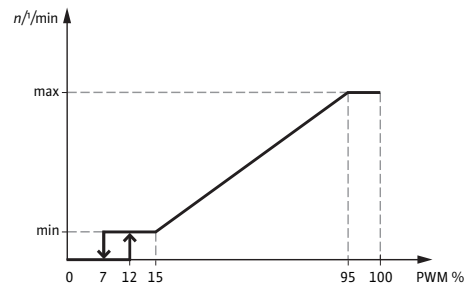

PWM input signal [%]

- 0-7 Pump stops (Standby)
- 7-15 Pump runs at minimum speed (operation)
- 12-15 Pump runs at minimum speed (start-up)
- 15-95 Pump speed increases linearly from minimum to maximum
- > 95 Pump runs at maximum speed

Signal frequency: 100 Hz-5000 Hz (1000 Hz nominal)

Signal amplitude: 5V-15V (min. power 5mA)

Signal polarity: both

Planning guide

Wilo-Stratos PARA

Manual control panel

Control button

The control mode and the differential pressure setpoint at Δp -c for constant differential pressure and at Δp -v for variable differential pressure can be set with the control button. The important basic functions can be set easily and safely, directly at the pump. Depending on customer wishes, a pre-setting of the control mode/setpoint can be done at the factory.



Local setting of the constant differential pressure setpoint at Δp -c at the pump



Local setting of the variable differential pressure setpoint at Δp -v at the pump



Power adjustment with a remote controller via 0-10 V or PWM signal

Electrical connection

To ensure a safe and easy electrical connection, the Wilo-Stratos PARA pumps are equipped with a mains cable or, depending on the available functions, with a mains and control cable as standard.



The cable is inseparably connected to the Stratos PARA pumps with a Wilo plug for Stratos PARA/-Z... 1-8; 1-11; 1-12.

Directly fixed at the electronic board of the Wilo-Stratos PARA.../1-7; 1-11.5:



Mains connection

3-core cable

For mains power supply 1~230 V/50 Hz

black/brown: L1, 1~230 V/50 Hz
blue: Neutral N
yellow/green: Earth conductor

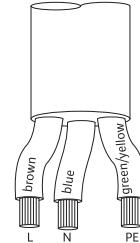

Control cables

Control via analogue signal 0...10 V (2-core cable or 4-core cable)

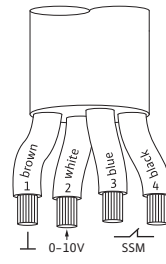

Core no. 1 (brown): GND (signal ground)
Core no. 2 (white): 0-10 V (signal)
Core no. 3 (blue): SSM (if available)
Core no. 4 (black): SSM (if available)

Note:

To ensure interference resistance, the total length of the 0-10 V control cable must not exceed 15 m.

Control via PWM (2-core cable or 4-core cable)

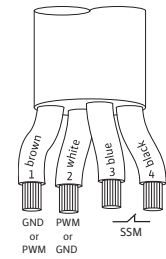
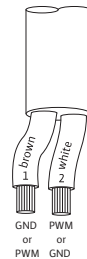

Core no. 1 (brown): PWM signal ground (GND) or PWM signal
Core no. 2 (white): PWM signal or PWM signal ground (GND)
Core no. 3 (blue): SSM (if available)
Core no. 4 (black): SSM (if available)

Note:

To ensure interference resistance, the total length of the PWM control cable must not exceed 3 m.

Wilo-Stratos PARA

Available cable versions

Pump type		
	Stratos PARA /1-7 Stratos PARA /1-11,5	Stratos PARA /1-8 Stratos PARA /1-11 Stratos PARA /1-12 Stratos PARA Z /1-8 Stratos PARA Z /1-11 Stratos PARA Z /1-12
Mains cable		
Standard	- 1.5 m with end splices	- 1.5 m with end splices
Optional	- 2.2 m cable with end splices	- 2.2 m cable with end splices
	- 3.2 m cable with end splices	- 3.2 m cable with end splices
	- 0.1 m with Wilo OEM plug	- 0.1 m with Wilo OEM plug
	- According to customer specification	- According to customer specification
Mains and 2-core control cable		
Standard	- 1.5 m with end splices	-
Optional	- According to customer specification	- According to customer specification
Mains and 4-core control cable		
Standard	- 1.5 m with end splices	- 1.5 m with end splices
Optional	- 2.2 m cable with end splices	- 2.2 m cable with end splices
	- 3.2 m cable with end splices	- 3.2 m cable with end splices
	- 0.2 m with Wilo OEM-plug	- 0.2 m with Wilo OEM-plug
	- According to customer specification	- According to customer specification

Standard mains and control cable with end splices

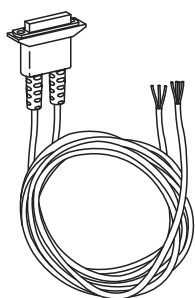

Mains and control cable with Wilo OEM plug

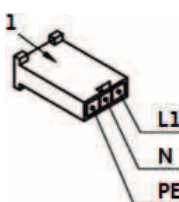
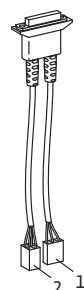

Assignment:
L1: brown
N: blue
PE: yellow/green

Pos. 1: Mains plug with female connector
Pos. 2: 4-pole control plug with pins

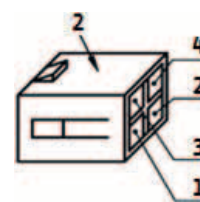

Assignment:
1: blue
2: white
3: black
4: brown

Collective fault signal, SSM

A collective fault signal is available as potential-free contact, designed as NC contact in accordance with VDI 3814.

Contact load:

- Permitted minimum: 12 V DC, 10 mA,
- Permitted maximum: 250 V AC, 1 A.

The contact is closed under the following conditions:

- The pump is without current
- There is no fault
- Total failure of the control module

The contact is open under the following conditions:

- The pump is powered and there is one of the following faults:
 - Excess motor temperature
 - Excess control module temperature
 - Excess current
 - Pump blockage
 - Short circuit and earth leakage
 - Faulty contact between motor/control module
 - Mains undervoltage
 - Mains overvoltage
 - Electronics faults

Planning guide

Wilo-Stratos PARA

Designation, name plate of the Wilo-Stratos PARA/-Z series

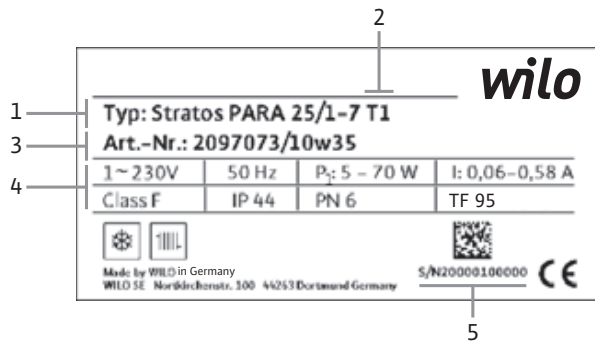

- 1 Pump type
- 2 Type no. of equipment/functions combination
- 3 Article numbers/production date (year/week)
- 4 Voltage/frequency/power consumption/electricity/insulation class/protection class IP/operating pressure PN/max. fluid temperature
- 5 Code and serial number

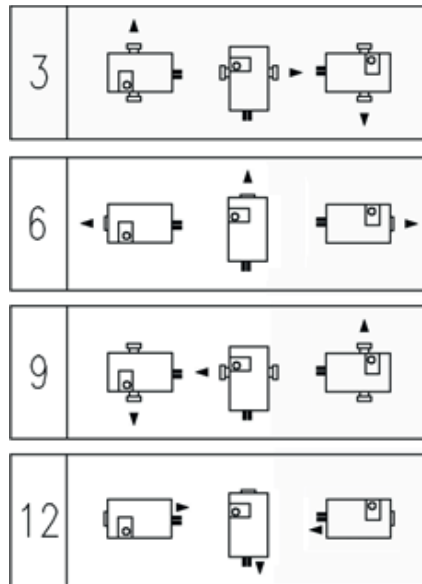

3, 6, 9 and 12 o'clock are the module positions for the indicated direction of flow at the pump housing.

Permitted installation positions

Wilo-Stratos PARA 1-7/1-11,5

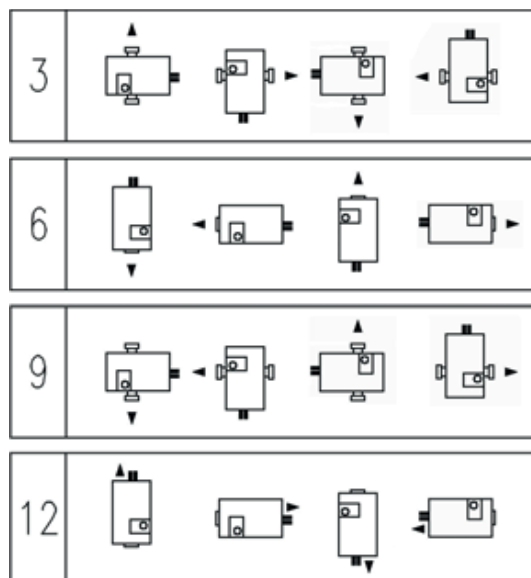

3, 6, 9 and 12 o'clock are the module positions for the indicated direction of flow at the pump housing.

Wilo-Stratos PARA/-Z 1-8/1-11/1-12

Possible combination of functions and equipment

Type No	Combination of function
T1	Control Element "red Button" Δp -c for constant differential pressure Δp -v for variable differential pressure Control input "Analog In 0 ... 10 V" with cable brake detection Collective fault signal SSM
T2	Control Element "red Button" Δp -c for constant differential pressure Δp -v for variable differential pressure Control input "Analog In 0 ... 10 V" with cable brake detection Collective fault signal SSM
T3	Control Element "red Button" Δp -c for constant differential pressure Δp -v for variable differential pressure In case the red Button set on the vertical position "Ext In" pump runs with the min speed
T6	Control input "Analog In 0 ... 10 V" with cable brake detection Collective fault signal SSM
T8	Control input "Analog In 0 ... 10 V" without cable brake detection Collective fault signal SSM
T10	Control input PWM 1
T11	Control input PWM 2
T12	Control input PWM 1 Collective fault signal SSM
T13	Control input PWM 2 Collective fault signal SSM
T16	Control Element "red Button" Δp -c for constant differential pressure Δp -v for variable differential pressure Control input "Analog In 0 ... 10 V" with cable brake detection
T17	Control Element "red Button" Δp -c for constant differential pressure Δp -v for variable differential pressure Control input "Analog In 0 ... 10 V" without cable brake detection
T18	Control input "Analog In 0 ... 10 V" with cable brake detection
T19	Control input "Analog In 0 ... 10 V" without cable brake detection
T20	Control Element "red Button" Δp -c for constant differential pressure Δp -v for variable differential pressure Control input PWM 1
T21	Control Element "red Button" Δp -c for constant differential pressure Δp -v for variable differential pressure Control input PWM 2
T22	Control Element "red Button" Δp -c for constant differential pressure Δp -v for variable differential pressure Control input PWM 1 Collective fault signal SSM
T24	Control Element "red Button" Δp -c for constant differential pressure Δp -v for variable differential pressure Control input PWM 2 Collective fault signal SSM

Geothermal energy systems

High-efficiency pumps

Series overview

Series: Wilo-Yonos PARA GT



> Application

Circulation in geothermal systems in the medium temperature range of $-20\text{ }^{\circ}\text{C}$ to $+95\text{ }^{\circ}\text{C}$.

> Special features/product advantages

- Red Knob technology or PWM controlled
- Unique LED user interface
- Self-protecting modes
- Designed for optimised integration
- Water temperature range: $0\text{ }^{\circ}\text{C}$ to $95\text{ }^{\circ}\text{C}$
- Ambient temperature range: $0\text{ }^{\circ}\text{C}$ to $70\text{ }^{\circ}\text{C}$
- Self controlled pump (Red Knob) or externally controlled (PWM signal)

> Additional information

- | | Page |
|---|------|
| • Yonos PARA GT 15/6, 25/6, 30/6 Red Knob | 136 |
| • Yonos PARA GT 15/7.0, 25/7.0, 30/7.0 PWM1 | 136 |
| • Yonos PARA GT 15/7.5, 25/7.5, 30/7.5 Red Knob, PWM1 | 139 |

Series: Wilo-Stratos PARA

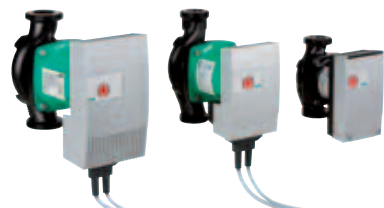

> Application

Hot-water heating systems of all kinds, closed cooling circuits, industrial circulation systems, circulation in solar thermal and geothermal systems.

> Special features/product advantages

- Application in the medium temperature range of $-10\text{ }^{\circ}\text{C}$ to $+95\text{ }^{\circ}\text{C}$ ($+110\text{ }^{\circ}\text{C}$) ambient temperature of $+25\text{ }^{\circ}\text{C}$
- Electronic performance control via external control signals $0-10\text{V}$ or PWM
- Convenient setting of the pump via Red Button technology with operating mode $\Delta p-c$ and $\Delta p-v$.
- Standard delivery with cable for an easy electrical connection

> Additional information

- | | Page |
|---|------|
| • Stratos PARA 15/1-7, 20/1-7, 25/1-7, 30/1-7 | 142 |
| • Stratos PARA 25/1-8, 30/1-8 | 145 |
| • Stratos PARA 25/1-11, 30/1-11 | 148 |
| • Stratos PARA 25/1-12, 30/1-12 | 151 |

Series overview

Hydraulic operational overview

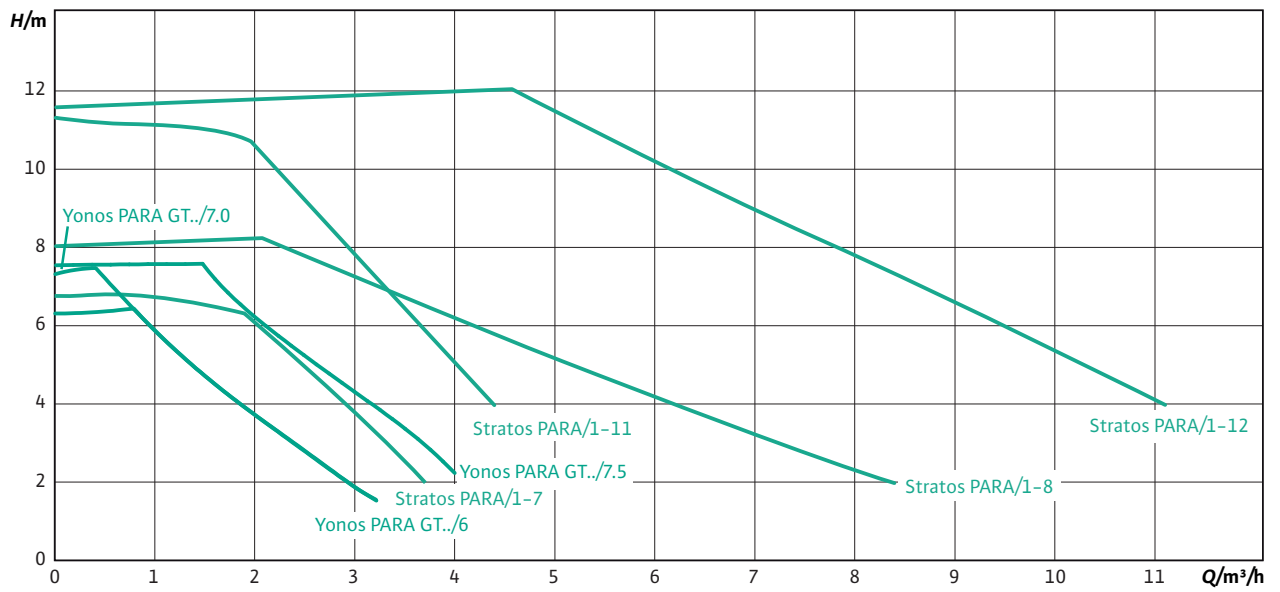

Geothermal energy systems

High-efficiency pumps

Equipment/function	Wilo-Yonos PARA GT...		
	15/6 RKC 25/6 RKC 30/6 RKC	15/7.5 RKC 25/7.5 RKC 30/7.5 RKC	15/7.0 (7.5) PWM1 25/7.0 (7.5) PWM1 30/7.0 (7.5) PWM1
Operating modes			
Manual control mode (n=constant)	• (RKC)	• (RKC)	• via PWM
Δp -c for constant differential pressure	• ($H_{\min.} = 1 \text{ m}$, $H_{\max.} = 6 \text{ m}$)	• ($H_{\min.} = 1 \text{ m}$, $H_{\max.} = 7.5 \text{ m}$)	–
Δp -v for variable differential pressure	–	–	–
Manual functions			
Operating mode setting	•	•	–
Differential-pressure setpoint setting	•	•	•
Automatic functions			
Infinitely variable power adjustment depending on the operating mode	•	•	•
Deblocking function	•	•	•
Soft start	•	•	•
Full motor protection with integrated trip electronics	–	–	–
Venting routine	–	–	–
External control functions			
Control input "Analogue In 0 ... 10 V" with cable break function (remote speed adjustment)	–	–	–
Control input "Analogue In 0 ... 10 V" without cable break function (remote setpoint adjustment)	–	–	–
Control input PWM	–	–	•
Signal and display functions			
Collective fault signal (potential-free NC contact)	–	–	–
Equipment/scope of delivery			
Red button	•	•	–
Version without red button (=external control)	–	–	•
Wrench attachment point on pump body	•	•	•
Including power cable	on request	•	•
Including power plug	on request	on request	on request
Including control cable	–	–	on request
Including seals for threaded connection	on request	on request	on request
Including installation and operating instructions	on request	on request	on request
Including thermal insulation	on request	on request	on request
Incl. Cooling-Shell for cooling	–	–	–
Individual packaging	on request	on request	on request
Collective packaging	•	•	•

Equipment/function

	Wilo-Stratos PARA...			
	15/1-7 20/1-7 25/1-7 30/1-7	25/1-8 30/1-8	25/1-11 30/1-11	25/1-12 30/1-12
Operating modes				
Manual control mode (n=constant)	• via Analog In 0-10 V or PWM	• via Analog In 0-10 V or PWM	• via Analog In 0-10 V or PWM	• via Analog In 0-10 V or PWM
Δp -c for constant differential pressure	• ($H_{min.} = 1$ m, $H_{max.} = 7$ m)	• ($H_{min.} = 1$ m, $H_{max.} = 7$ m)	• ($H_{min.} = 2$ m, $H_{max.} = 10$ m)	• ($H_{min.} = 2$ m, $H_{max.} = 11$ m)
Δp -v for variable differential pressure	• ($H_{min.} = 2$ m, $H_{max.} = 6$ m)	• ($H_{min.} = 2$ m, $H_{max.} = 7$ m)	• ($H_{min.} = 4$ m, $H_{max.} = 10$ m)	• ($H_{min.} = 4$ m, $H_{max.} = 10$ m)
Manual functions				
Operating mode setting	•	•	•	•
Differential-pressure setpoint setting	•	•	•	•
Automatic functions				
Infinitely variable power adjustment depending on the operating mode	•	•	•	•
Deblocking function	•	•	•	•
Soft start	•	•	•	•
Full motor protection with integrated trip electronics	•	•	•	•
Venting routine	-	-	-	-
External control functions				
Control input "Analogue In 0 ... 10 V" with cable break function (remote speed adjustment)	on request*	on request*	on request*	on request*
Control input "Analogue In 0 ... 10 V" without cable break function (remote setpoint adjustment)	on request*	on request*	on request*	on request*
Control input PWM	on request*	on request*	on request*	on request*
Signal and display functions				
Collective fault signal (potential-free NC contact)	•	•	•	•
Equipment/scope of delivery				
Red button	•	•	•	•
Version without red button (=external control)	•	•	•	•
Wrench attachment point on pump body	•	•	•	•
Including power cable	•	•	•	•
Including power plug	-	-	-	-
Including control cable	on request	on request	on request	on request
Including seals for threaded connection	on request	on request	on request	on request
Including installation and operating instructions	on request	on request	on request	on request
Including thermal insulation	on request	on request	on request	on request
Incl. Cooling-Shell for cooling	on request	on request	on request	on request
Individual packaging	•	•	•	•
Collective packaging	• on request 196 pumps/box	• on request 108 pumps/box	• on request 108 pumps/box	• on request 72 pumps/box

• = available, - = not available

* see table "Possible combinations of functions and equipment"

Geothermal energy systems

High-efficiency pumps

Series description Wilo-Stratos PARA 15/1-7, 20/1-7, 25/1-7, 30/1-7



Design

Glandless circulation pump with cast iron pump housing and threaded connection. EC-motor with automatic power adjustment and self-protecting modes. Operation by Red Knob technology and delivered with power cable.

Application

Hot-water heating systems of all kinds, closed cooling circuits, industrial circulation systems, circulation in solar thermal and geothermal systems.

Type key

Example:	Wilo-Stratos PARA 25/1-7 T1
Stratos	Electronically controlled high-efficiency pump
PARA	Pump range adapted to requirements of the OEM market
25/	Nominal connection diameter
1-7	Nominal delivery head range [m]
T1	Type key for combinations of function and equipment
12 h	Position of electronic module, special version
(not specified)	Position of electronic module 6h, standard version

Options

- External control via 0-10V or PWM
- Control mode $\Delta p-c$ (constant), $\Delta p-v$ (variable)
- Control mode selection and differential pressure setpoint setting for $\Delta p-c$, $\Delta p-v$ via operating button
- Special version without operating button
- Further combinations of functions and equipment are available: T1-T3, T6, T8, T10-T13, T16-T19, T27
- Version with cable according to customer specification
- Version with short overall length of 130 mm
- Delivery in collective packaging (196 pumps/packaging)
- Delivery with thermal insulation
- Cold insulation Cooling-Shell as accessories
- Version for application at 110 °C, 10 bar (ambient temperature max. 40 °C) on request

Technical data

Approved fluids (other fluids on request)	
Heating water (in accordance with VDI 2035)	•
Water-glycol mixtures (max. 1:1; above 20% admixture, the pumping data must be checked)	•
Power	
Energy efficiency index (EEI)	≤ 0.23
Max. delivery head	7 m
Max. volume flow	4.5 m ³ /h
Permitted field of application	
Temperature range at max. ambient temperature	of 25 °C = -10 to 95 °C of 40 °C = -10 to 95 °C of 45 °C = -10 to 95 °C of 50 °C = -10 to 90 °C of 55 °C = -10 to 80 °C of 60 °C = -10 to 70 °C of 65 °C = -10 to 60 °C
Maximum static pressure	6 bar
Electrical connection	
Mains connection	1~230 V, 50/60 Hz
Motor/electronics	
Electromagnetic compatibility	EN 61800-3
Emitted interference	EN 61000-6-3
Interference resistance	EN 61000-6-2
Speed control	Frequency converter
Protection class	IP 44
Insulation class	F
Minimum suction head at suction port [m] for preventing cavitation at water pumping temperature*	
Minimum suction head at 50 / 95 / 110 °C	0.5 / 4.5 / - m

*lower values are possible under specific conditions. Please contact our technical services.

Pump curves Wilo-Stratos PARA 15/1-7, 20/1-7, 25/1-7, 30/1-7

Wilo-Stratos PARA 15/1-7, 20/1-7, 25/1-7, 30/1-7

Δp-c (constant)

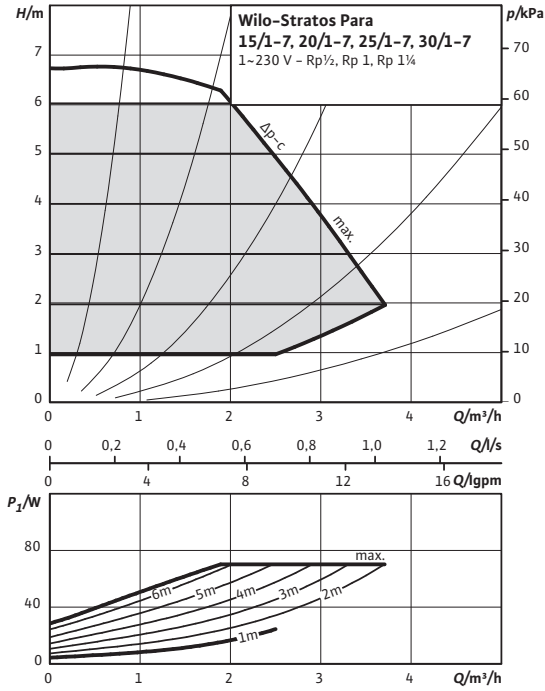

Wilo-Stratos PARA 15/1-7, 20/1-7, 25/1-7, 30/1-7

Δp-v (variable)

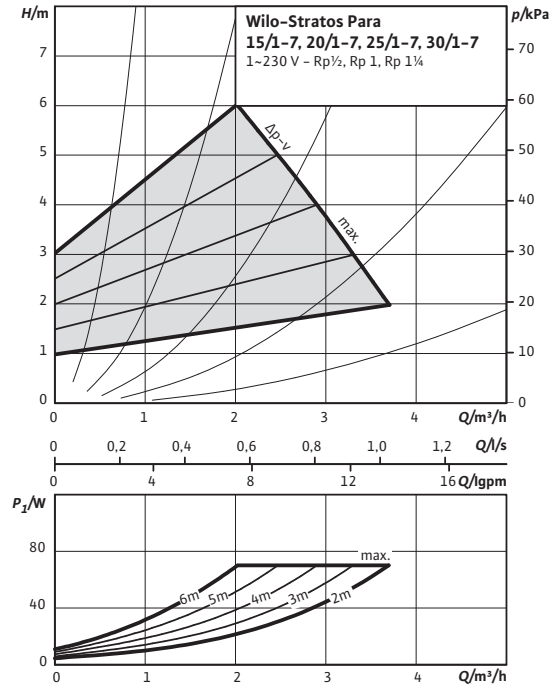

Wilo-Stratos PARA 15/1-7, 20/1-7, 25/1-7, 30/1-7

External control mode via Analog-In 0-10 V

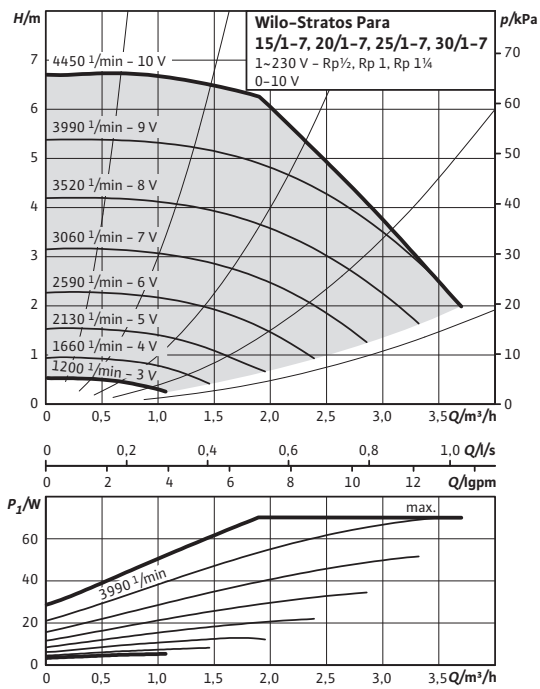

Wilo-Stratos PARA 15/1-7, 20/1-7, 25/1-7, 30/1-7

External control via PWM

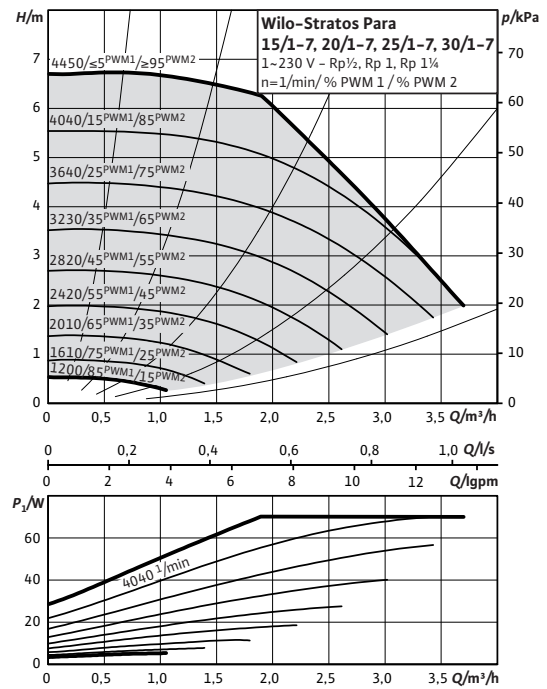

Geothermal energy systems

High-efficiency pumps

Dimensions, motor data Wilo-Stratos PARA 15/1-7, 20/1-7, 25/1-7, 30/1-7

Motor data

Wilo-Stratos PARA...	Speed	Power consumption 1~230 V	Current at 1~230V	Motor protection
	n	P_1	I	–
	rpm	W	A	–
.../1-7	1200 - 4450	5-70	0.06 - 0.58	integrated

Materials

Wilo-Stratos PARA...	Pump housing	Impeller	Pump shaft	Bearing
.../1-7	Grey cast iron (EN-GJL-200)	Plastic (PP - 50% GF)	Stainless steel (X46Cr13)	Carbon, metal impregnated

Dimension drawing

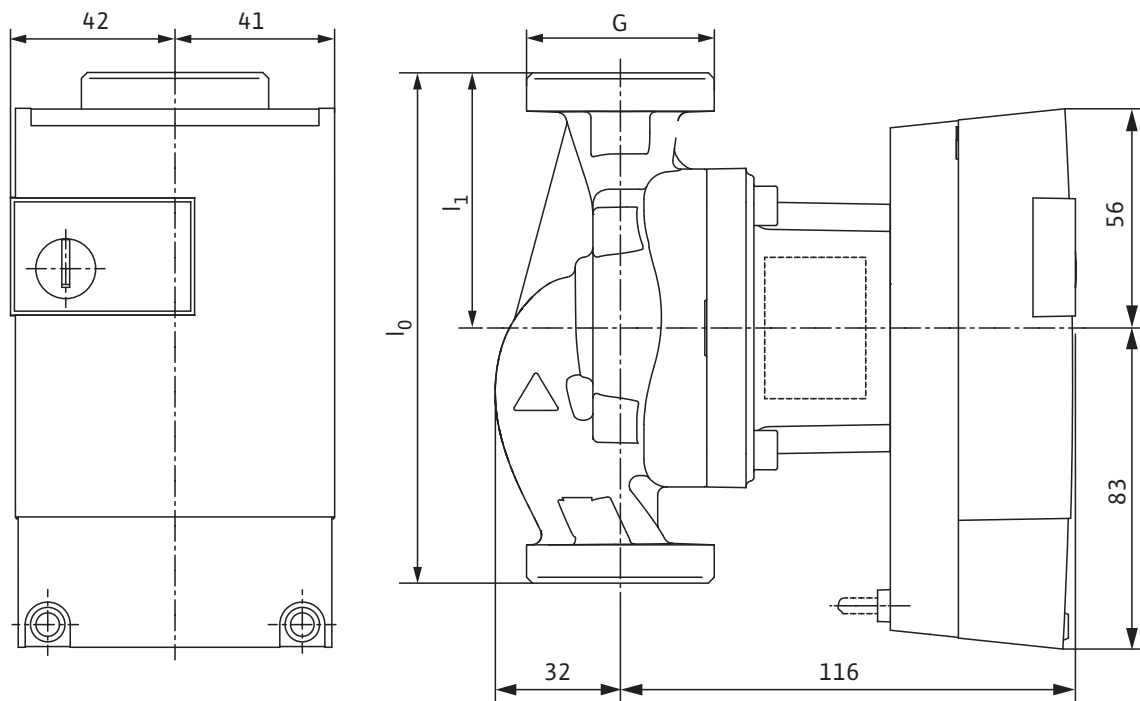

Dimensions, weights

Wilo-Stratos PARA...	Threaded pipe union	Thread	Overall length	Weight approx.
		–	l_0	m
		–	mm	kg
15/1-7	Rp 1/2	G 1	130	2.2
20/1-7	Rp 3/4	G 1 1/4	130	2.2
25/1-7	Rp 1	G 1 1/2	180	2.5
25/1-7	Rp 1	G 1 1/2	130	2.2
30/1-7	Rp 1 1/4	G 2	180	2.5
30/1-7	Rp 1 1/4	G 2	130	2.5

Geothermal energy systems

High-efficiency pumps

wilo

Series description Wilo-Stratos PARA 25/1-8, 30/1-8

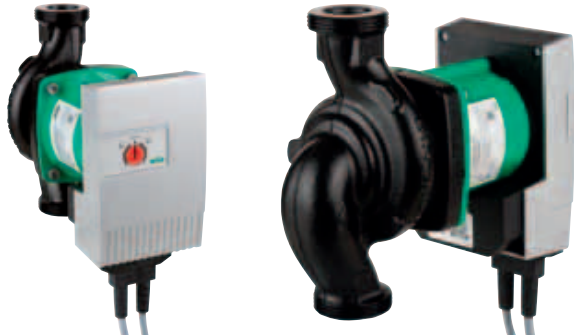

Design

Glandless circulation pump with cast iron pump housing and threaded connection. EC-motor with automatic power adjustment and self-protecting modes. Operation by Red Knob technology and delivered with power cable.

Application

Hot-water heating systems of all kinds, closed cooling circuits, industrial circulation systems, circulation in solar thermal and geothermal systems.

Type key

Example:	Wilo-Stratos PARA 25/1-8 T1
Stratos	Electronically controlled high-efficiency pump
PARA	Pump range adapted to requirements of the OEM market
25/	Nominal connection diameter
1-8	Nominal delivery head range [m]
T1	Type key for combinations of function and equipment
12 h	Position of electronic module, special version
(not specified)	Position of electronic module 6h, standard version

Options

- External control via 0-10V or PWM
- Control mode Δp -c (constant), Δp -v (variable)
- Control mode selection and differential pressure setpoint setting for Δp -c, Δp -v via operating button
- Special version without operating button
- All possible combinations of functions and equipment are available
- Version with cable according to customer specification
- Delivery in collective packaging (108 pumps/package)
- Delivery with thermal insulation
- Cold insulation Cooling-Shell as accessories

Technical data

Approved fluids (other fluids on request)

Heating water (in accordance with VDI 2035) •

Water-glycol mixtures (max. 1:1; above 20% admixture, the pumping data must be checked) •

Power

Energy efficiency index (EEI) ≤ 0.23

Max. delivery head 8 m

Max. volume flow 8.0 m³/h

Permitted field of application

Temperature range at max. ambient temperature	of 25°C = -10 to 110°C of 40°C = -10 to 90°C of 45°C = -10 to 80°C of 50°C = -10 to 70°C of 55°C = -10 to 60°C of 60°C = -10 to 50°C of 65°C = -10 to 40°C
---	--

Maximum static pressure 10 bar

Electrical connection

Mains connection 1~230 V, 50/60 Hz

Motor/electronics

Electromagnetic compatibility EN 61800-3

Emitted interference EN 61000-6-3

Interference resistance EN 61000-6-2

Speed control Frequency converter

Protection class IP X4D

Insulation class F

Minimum suction head at suction port [m] for preventing cavitation at water pumping temperature*

Minimum suction head at 50 / 95 / 110 °C 3 / 10 / 16 m

*lower values are possible under specific conditions. Please contact our technical services.

Geothermal energy systems

High-efficiency pumps

Pump curves Wilo-Stratos PARA 25/1-8, 30/1-8

Wilo-Stratos PARA 25/1-8, 30/1-8

Δp -c (constant)

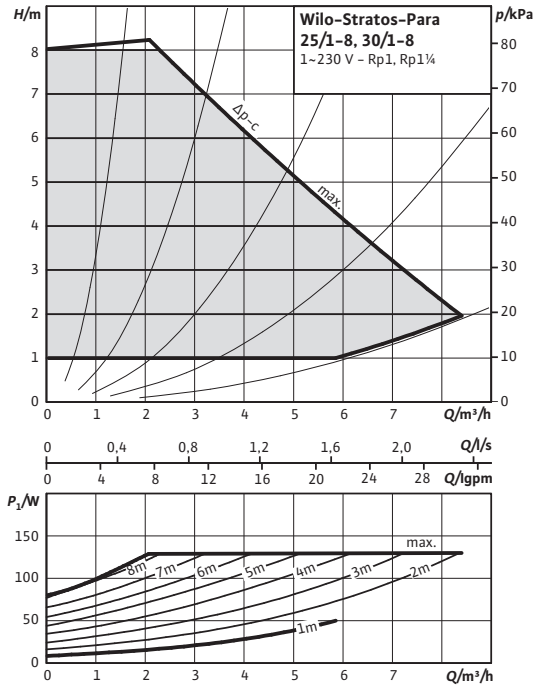

Wilo-Stratos PARA 25/1-8, 30/1-8

Δp -v (variable)

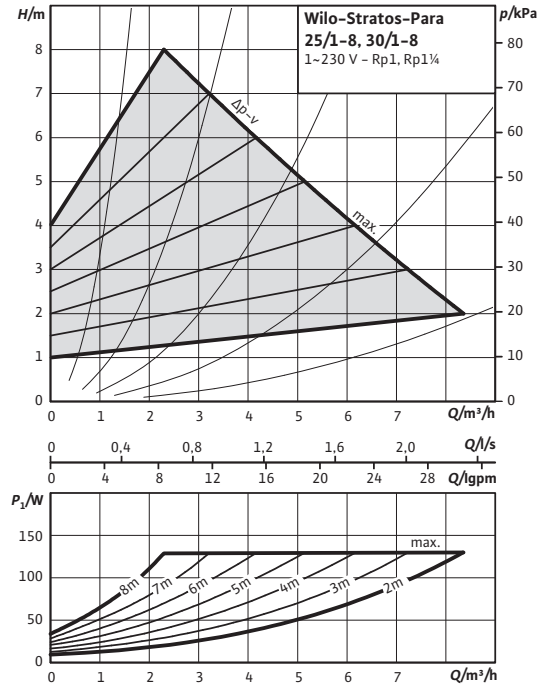

Wilo-Stratos PARA 25/1-8, 30/1-8

External control mode via Analog-In 0-10 V

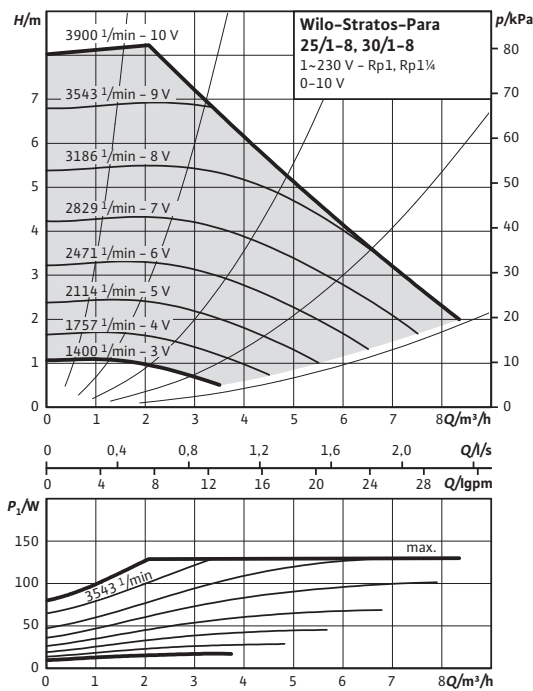

Wilo-Stratos PARA 25/1-8, 30/1-8

External control via PWM

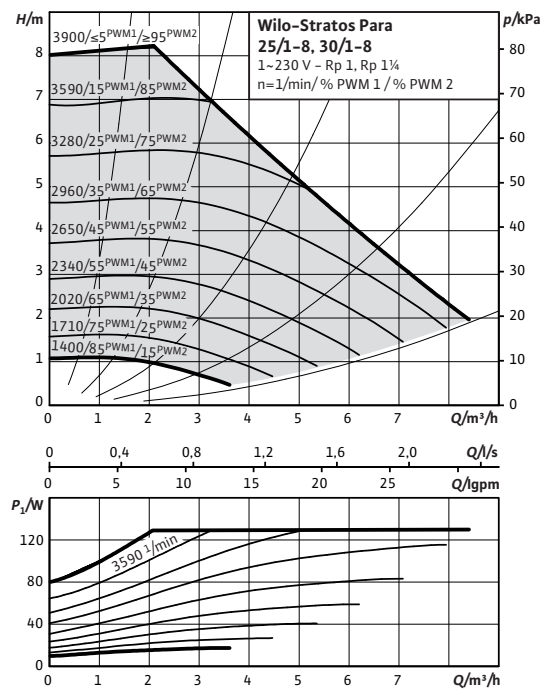

Dimensions, motor data Wilo-Stratos PARA 25/1-8, 30/1-8

Motor data

Wilo-Stratos PARA...	Speed	Power consumption 1~230 V	Current at 1~230V	Motor protection
	n	P_1	I	-
	rpm	W	A	-
.../1-8	1400 - 3900	8-130	0.07 - 0.95	integrated

Materials

Wilo-Stratos PARA...	Pump housing	Impeller	Pump shaft	Bearing
.../1-8	Grey cast iron (EN-GJL-200)	Plastic (PPS - 40% GF)	Stainless steel (X46Cr13)	Carbon, metal impregnated

Dimension drawing

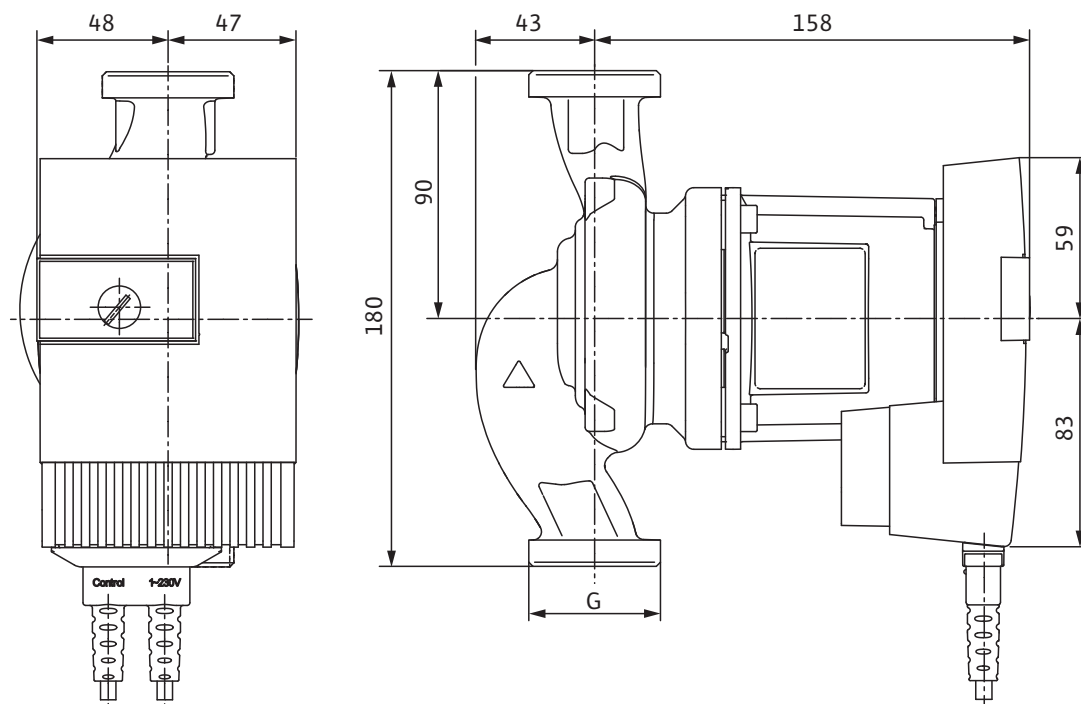

Dimensions, weights

Wilo-Stratos PARA...	Threaded pipe union	Thread	Weight approx.
		-	m
		-	kg
25/1-8	Rp 1	G 1½	4.7
30/1-8	Rp 1¼	G 2	4.7

Geothermal energy systems

High-efficiency pumps

Series description Wilo-Stratos PARA 25/1-11, 30/1-11



Design

Glandless circulation pump with cast iron pump housing and threaded connection. EC-motor with automatic power adjustment and self-protecting modes. Operation by Red Knob technology and delivered with power cable.

Application

Hot-water heating systems of all kinds, closed cooling circuits, industrial circulation systems, circulation in solar thermal and geothermal systems.

Type key

Example:	Wilo-Stratos PARA 25/1-11 T1
Stratos	Electronically controlled high-efficiency pump
PARA	Pump range adapted to requirements of the OEM market
25/	Nominal connection diameter
1-11	Nominal delivery head range [m]
T1	Type key for combinations of function and equipment
12 h	Position of electronic module, special version
(not specified)	Position of electronic module 6h, standard version

Options

- External control via 0-10V or PWM
- Control mode Δp -c (constant), Δp -v (variable)
- Control mode selection and differential pressure setpoint setting for Δp -c, Δp -v via operating button
- Special version without operating button
- All possible combinations of functions and equipment are available
- Version with cable according to customer specification
- Version with short overall length of 130 mm
- Delivery in collective packaging (108 pumps/package)
- Delivery with thermal insulation
- Cold insulation Cooling-Shell as accessories

Technical data	
Approved fluids (other fluids on request)	
Heating water (in accordance with VDI 2035)	•
Water-glycol mixtures (max. 1:1; above 20% admixture, the pumping data must be checked)	•
Power	
Energy efficiency index (EEI)	≤ 0.23
Max. delivery head	11 m
Max. volume flow	4.5 m ³ /h
Permitted field of application	
Temperature range at max. ambient temperature	of 25°C = -10 to 110°C of 40°C = -10 to 90°C of 45°C = -10 to 80°C of 50°C = -10 to 70°C of 55°C = -10 to 60°C of 60°C = -10 to 50°C of 65°C = -10 to 40°C
Maximum static pressure	10 bar
Electrical connection	
Mains connection	1~230 V, 50/60 Hz
Motor/electronics	
Electromagnetic compatibility	EN 61800-3
Emitted interference	EN 61000-6-3
Interference resistance	EN 61000-6-2
Speed control	Frequency converter
Protection class	IP X4D
Insulation class	F
Minimum suction head at suction port [m] for preventing cavitation at water pumping temperature*	
Minimum suction head at 50 / 95 / 110 °C	3 / 10 / 16 m

*lower values are possible under specific conditions. Please contact our technical services.

Pump curves Wilo-Stratos PARA 25/1-11, 30/1-11

Wilo-Stratos PARA 25/1-11, 30/1-11

Δp -c (constant)

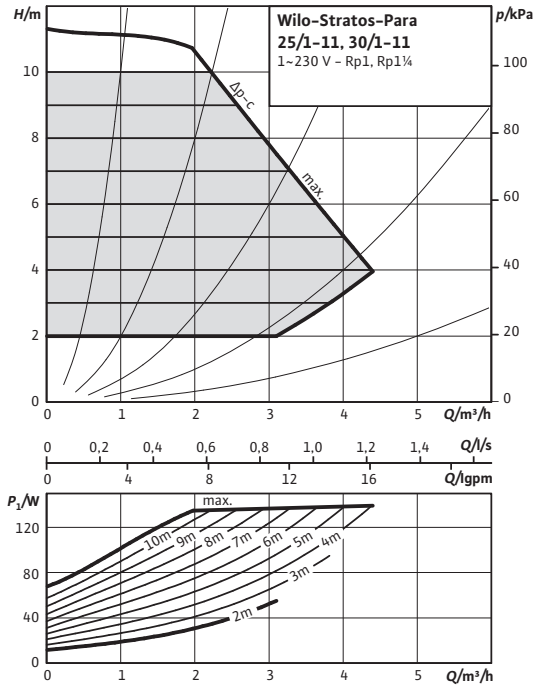

Wilo-Stratos PARA 25/1-11, 30/1-11

Δp -v (variable)

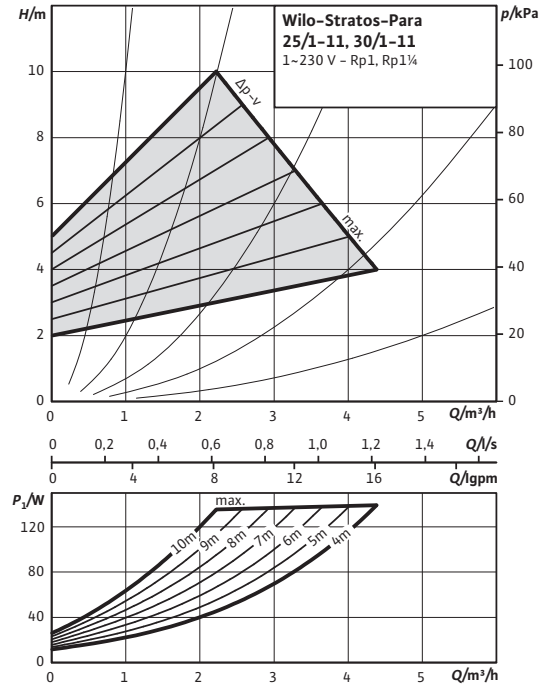

Wilo-Stratos PARA 25/1-11, 30/1-11

External control mode via Analog-In 0-10 V

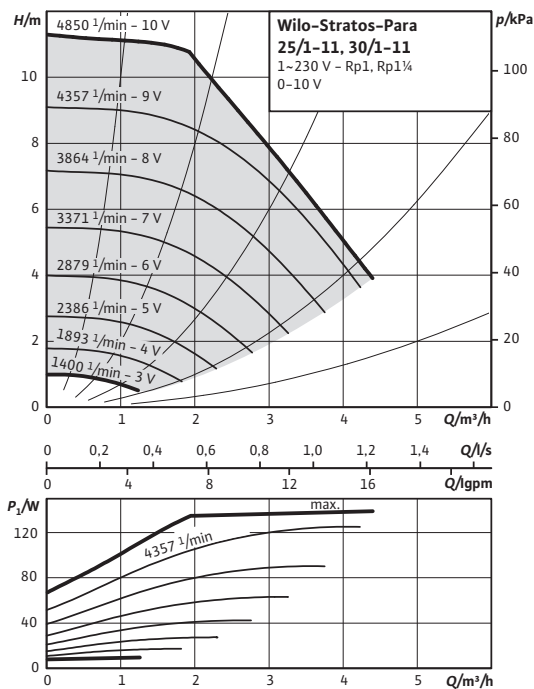

Wilo-Stratos PARA 25/1-11, 30/1-11

External control via PWM

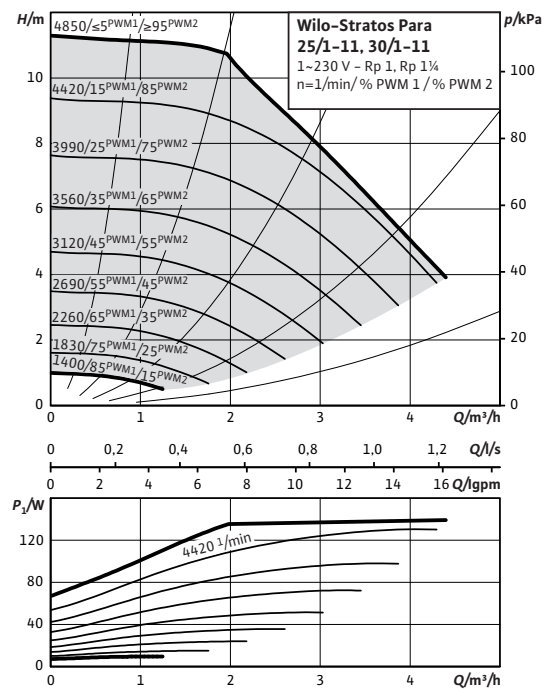

Geothermal energy systems

High-efficiency pumps

Dimensions, motor data Wilo-Stratos PARA 25/1-11, 30/1-11

Motor data

Wilo-Stratos PARA...	Speed	Power consumption 1~230 V	Current at 1~230V	Motor protection
	n	P_1	I	–
	rpm	W	A	–
.../1-11	1400 - 4850	8-140	0.07 - 1.05	integrated

Materials

Wilo-Stratos PARA...	Pump housing	Impeller	Pump shaft	Bearing
.../1-11	Grey cast iron (EN-GJL-200)	Plastic (PPE - 30% GF)	Stainless steel (X46Cr13)	Carbon, metal impregnated

Dimension drawing

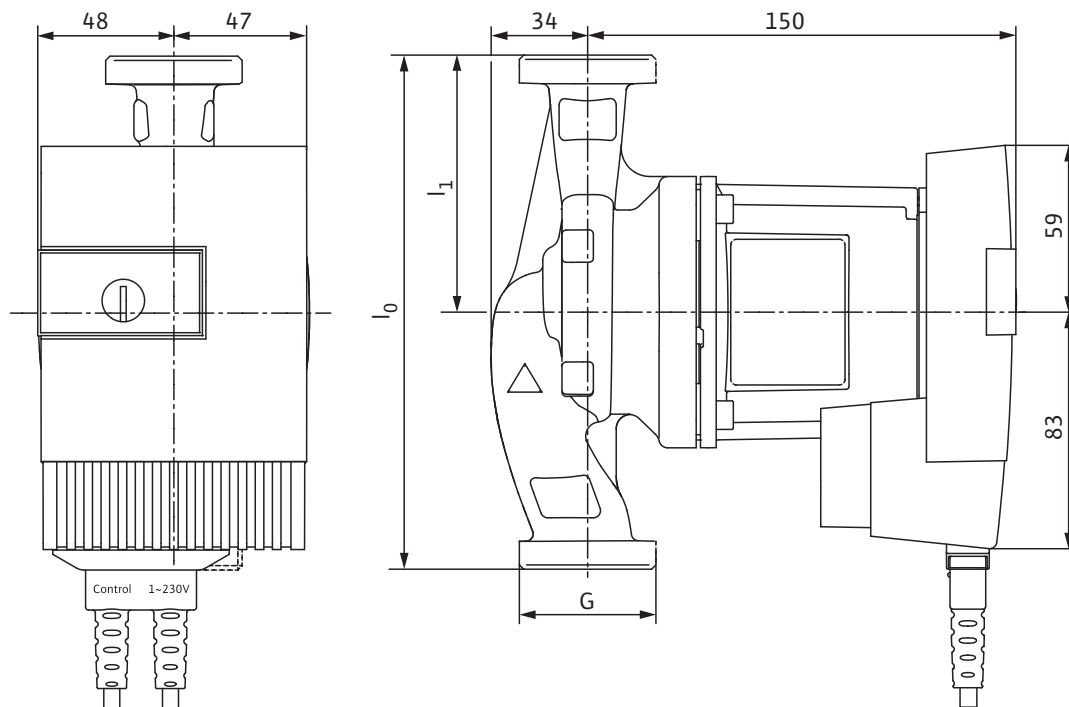

Dimensions, weights

Wilo-Stratos PARA...	Threaded pipe union	Thread	Overall length	Dimensions	Weight approx.
	–		l_0	$L1$	m
	–			mm	kg
25/1-11	Rp 1	G 1½	180	90	4.3
25/1-11	Rp 1	G 1½	130	65	4.3
30/1-11	Rp 1¼	G 2	180	90	4.3

Geothermal energy systems

High-efficiency pumps

wilo

Series description Wilo-Stratos PARA 25/1-12, 30/1-12



Design

Glandless circulation pump with cast iron pump housing and threaded connection. EC-motor with automatic power adjustment and self-protecting modes. Operation by Red Knob technology and delivered with power cable.

Application

Hot-water heating systems of all kinds, closed cooling circuits, industrial circulation systems, circulation in solar thermal and geothermal systems.

Type key

Example:	Wilo-Stratos PARA 25/1-12 T1
Stratos	Electronically controlled high-efficiency pump
PARA	Pump range adapted to requirements of the OEM market
25/	Nominal connection diameter
1-12	Nominal delivery head range [m]
T1	Type key for combinations of function and equipment
12 h	Position of electronic module, special version
(not specified)	Position of electronic module 6h, standard version

Options

- External control via 0-10V or PWM
- Control mode Δp -c (constant), Δp -v (variable)
- Control mode selection and differential pressure setpoint setting for Δp -c, Δp -v via operating button
- Special version without operating button
- All possible combinations of functions and equipment are available
- Version with cable according to customer specification
- Delivery in collective packaging (72 pumps/packaging)
- Delivery with thermal insulation
- Cold insulation Cooling-Shell as accessories

Technical data

Approved fluids (other fluids on request)

Heating water (in accordance with VDI 2035) •

Water-glycol mixtures (max. 1:1; above 20% admixture, the pumping data must be checked) •

Power

Energy efficiency index (EEI) ≤ 0.23

Max. delivery head 12 m

Max. volume flow 10.0 m³/h

Permitted field of application

Temperature range at max. ambient temperature	of 25°C = -10 to 110°C of 40°C = -10 to 90°C of 45°C = -10 to 80°C of 50°C = -10 to 65°C of 55°C = -10 to 50°C of 60°C = -10 to 35°C of 65°C = -10 to 20°C
Maximum static pressure	10 bar

Electrical connection

Mains connection 1~230 V, 50/60 Hz

Motor/electronics

Electromagnetic compatibility EN 61800-3

Emitted interference EN 61000-6-3

Interference resistance EN 61000-6-2

Speed control Frequency converter

Protection class IP X4D

Insulation class F

Minimum suction head at suction port [m] for preventing cavitation at water pumping temperature*

Minimum suction head at 50 / 95 / 110 °C 3 / 10 / 16 m

*lower values are possible under specific conditions. Please contact our technical services.

Geothermal energy systems

High-efficiency pumps

Pump curves Wilo-Stratos PARA 25/1-12, 30/1-12

Wilo-Stratos PARA 25/1-12, 30/1-12

Δp -c (constant)

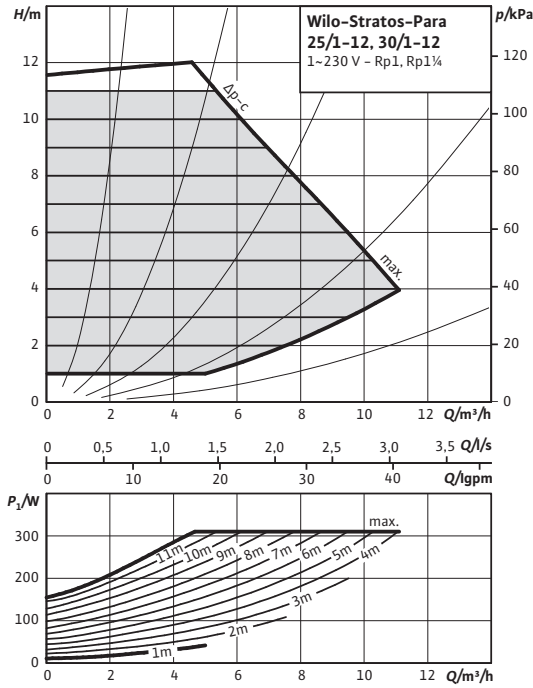

Wilo-Stratos PARA 25/1-12, 30/1-12

Δp -v (variable)

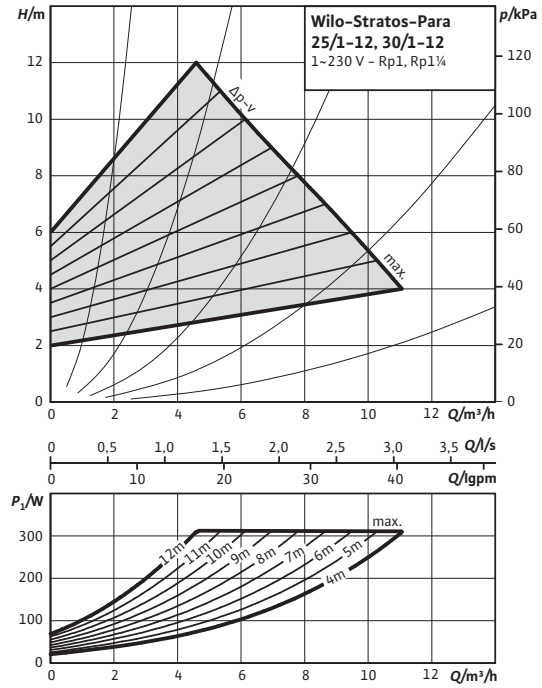

Wilo-Stratos PARA 25/1-12, 30/1-12

External control mode via Analog-In 0-10 V

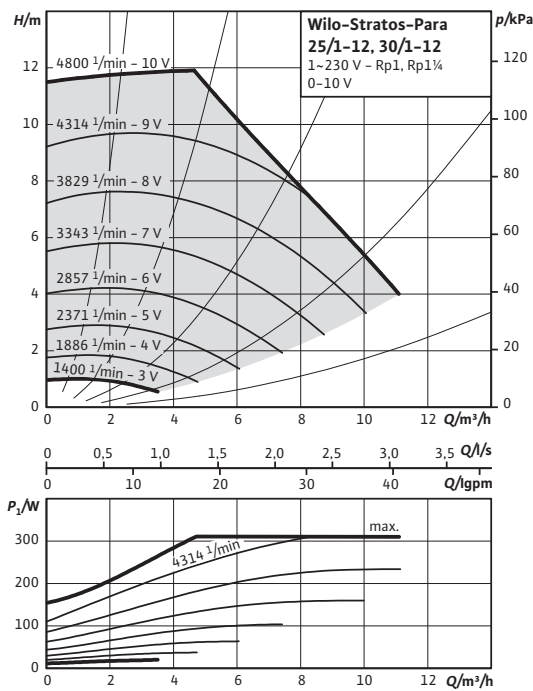

Wilo-Stratos PARA 25/1-12, 30/1-12

External control via PWM

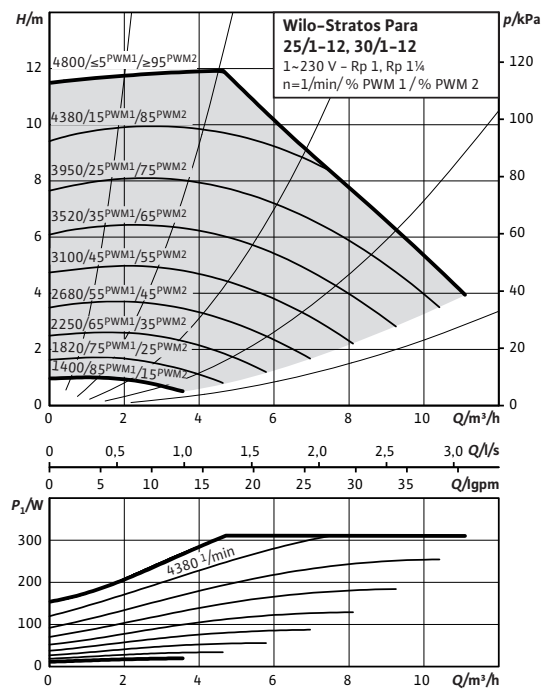

Dimensions, motor data Wilo-Stratos PARA 25/1-12, 30/1-12

Motor data

Wilo-Stratos PARA...	Speed	Power consumption 1~230 V	Current at 1~230V	Motor protection
	n	P_1	I	–
	rpm	W	A	–
.../1-12	1400 - 4800	16-310	0.16 - 1.37	integrated

Materials

Wilo-Stratos PARA...	Pump housing	Impeller	Pump shaft	Bearing
.../1-12	Grey cast iron (EN-GJL-200)	Plastic (PPS - 40% GF)	Stainless steel (X46Cr13)	Carbon, metal impregnated

Dimension drawing

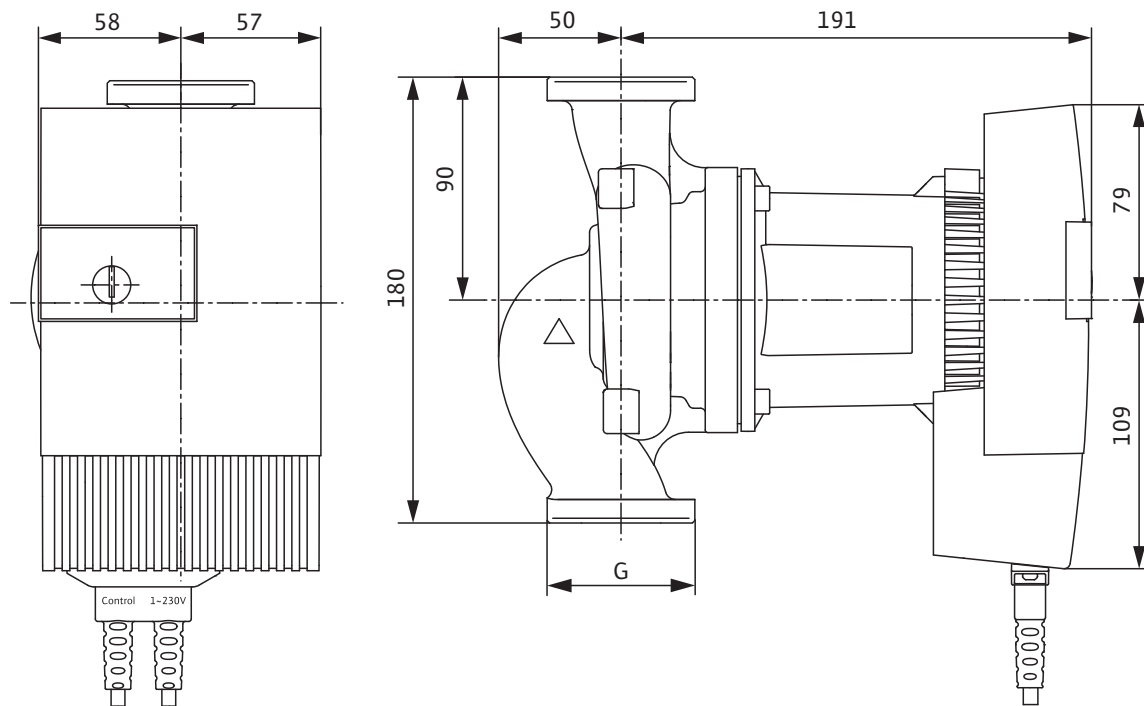

Dimensions, weights

Wilo-Stratos PARA...	Threaded pipe union	Thread	Weight approx.
		–	m
		–	kg
25/1-12	Rp 1	G 1½	6.2
30/1-12	Rp 1¼	G 2	6.2



Subject to change without prior notice.

Version 13.02/September 2013 Wilo Intec/EN

Wilo
HVAC OEM competence centre

50 av. Casella
F-18700 Aubigny sur Nère
T +33 2 48 81 62 62
F +33 2 48 58 20 29
information@wilointec.com
www.wilointec.com